

MODEL#711-1006

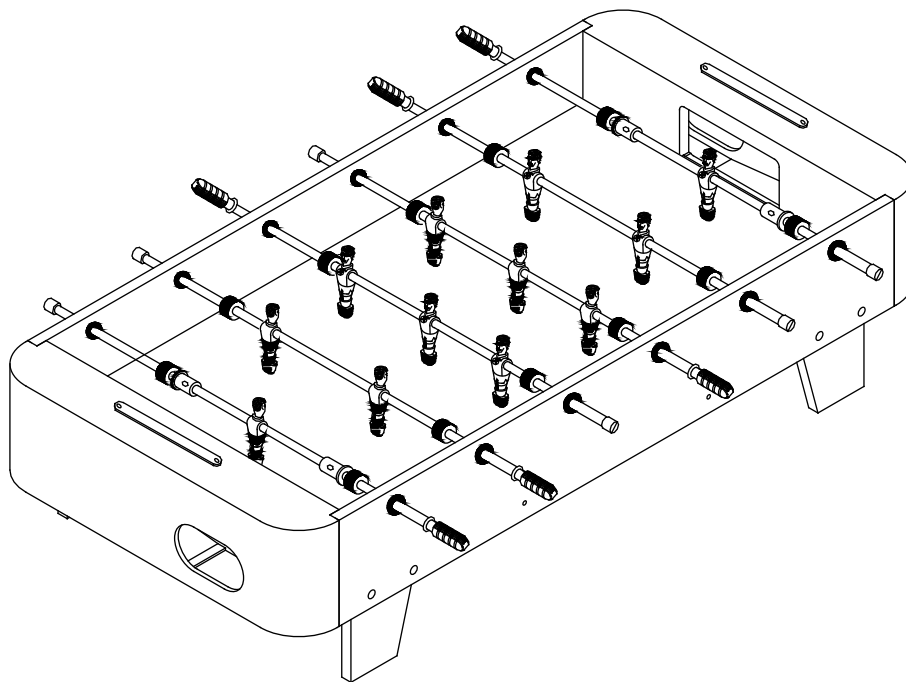









# ***SOCCKER TABLE***

## **INSTRUCTIONS**

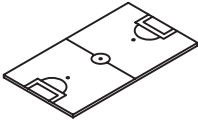

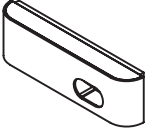
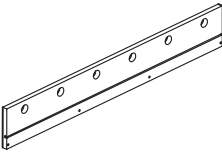
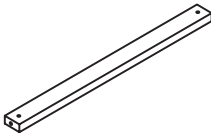
# Soccer Table Assembly Instructions

The parts included with your new Soccer Table are listed below. Before attempting assembly, please read through the instructions to familiarize yourself with all the parts and assembly steps. Assembly by an adult is recommended. Please refer to the Parts List below and make sure that all parts have been included.

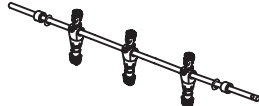
<p><b>#1</b></p>  <p>6X30mm Leg Bolt 8 e.a.</p>	<p><b>#2</b></p>  <p>18X6.5mm Washer 8 e.a.</p>	<p><b>#3</b></p>  <p>4X45mm Washer Head Screw 16 e.a.</p>	<p><b>#4</b></p>  <p>4X12mm Washer Head Screw 4 e.a.</p>
<p><b>#5</b></p>  <p>Allen Wrench 1 e.a.</p>	<p><b>#6</b></p>  <p>Playingfield 1 e.a.</p>	<p><b>#7</b></p>  <p>Right Leg 2 e.a.</p>	<p><b>#8</b></p>  <p>Left Leg 2 e.a.</p>
<p><b>#9</b></p>  <p>End Apron 2 e.a.</p>	<p><b>#10</b></p>  <p>Side Apron 2 e.a.</p>	<p><b>#11</b></p>  <p>Playfield Support Brace 2 e.a.</p>	<p><b>#12</b></p>  <p>Slide Scorer 2 e.a.</p>
<p><b>#13</b></p>  <p>Rod Handle 6 e.a.</p>	<p><b>#14</b></p>  <p>Rod Cap 6 e.a.</p>	<p><b>#15</b></p>  <p>Soccer Ball 2 e.a.</p>	<p><b>#16</b></p>  <p>3 Home Players Rod 1 e.a.</p>

Recommended Tools: Powered screwdriver with Phillip and standard screwdriver bits

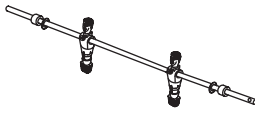
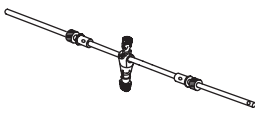
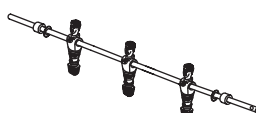
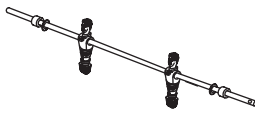
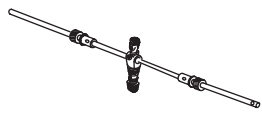
<p><b>#17</b></p>  <p>2 Home Players Rod 1 e.a.</p>	<p><b>#18</b></p>  <p>1 Home Player Rod 1 e.a.</p>	<p><b>#19</b></p>  <p>3 Away Players Rod 1 e.a.</p>	<p><b>#20</b></p>  <p>2 Away Players Rod 1 e.a.</p>
<p><b>#21</b></p>  <p>1 Away Player Rod 1 e.a.</p>			

## Assembly instructions for 711-1006 soccer table

**Step 1** -Insert Home Payers through Away Payers (follow below shown) into Side Apron( #10). (Place Side Apron upside down so the holes for the men are closest to the floor before inserting the men)

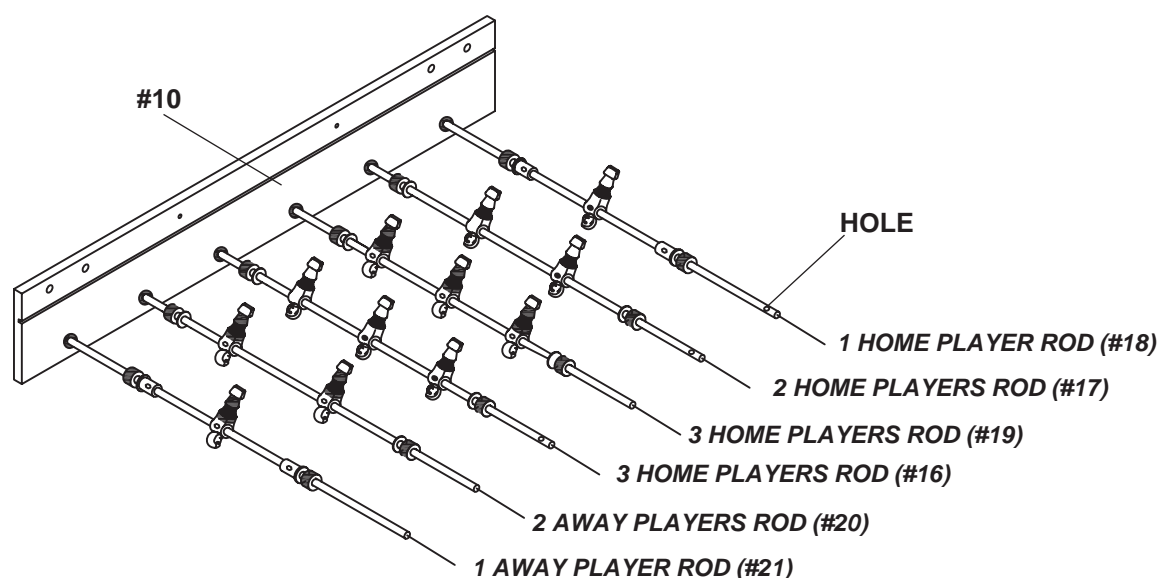

**Step 2-** Place other Side Apron (#10) over other end of rods. Insert Playing field (#6) (upside down) into side panels.

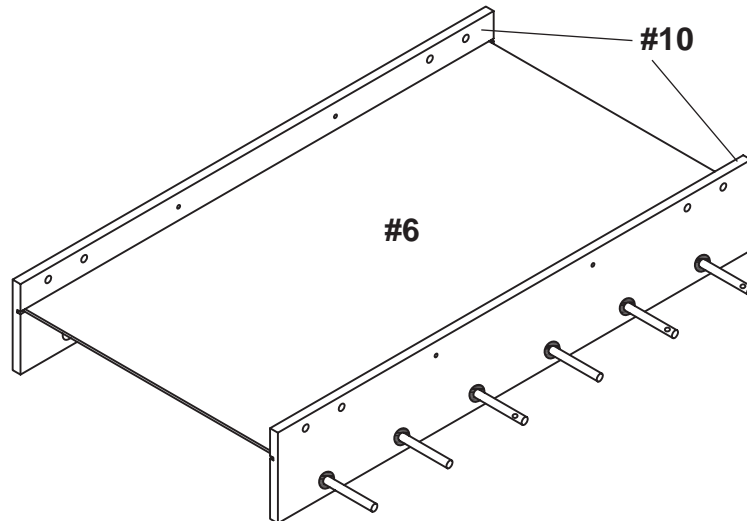

**Step 3-** Attach End Apron (# 9 ) to each end of the table using Washer head screws (#3) .Place the playfield Support Braces (#11) on the playing field using the Screws (#3).

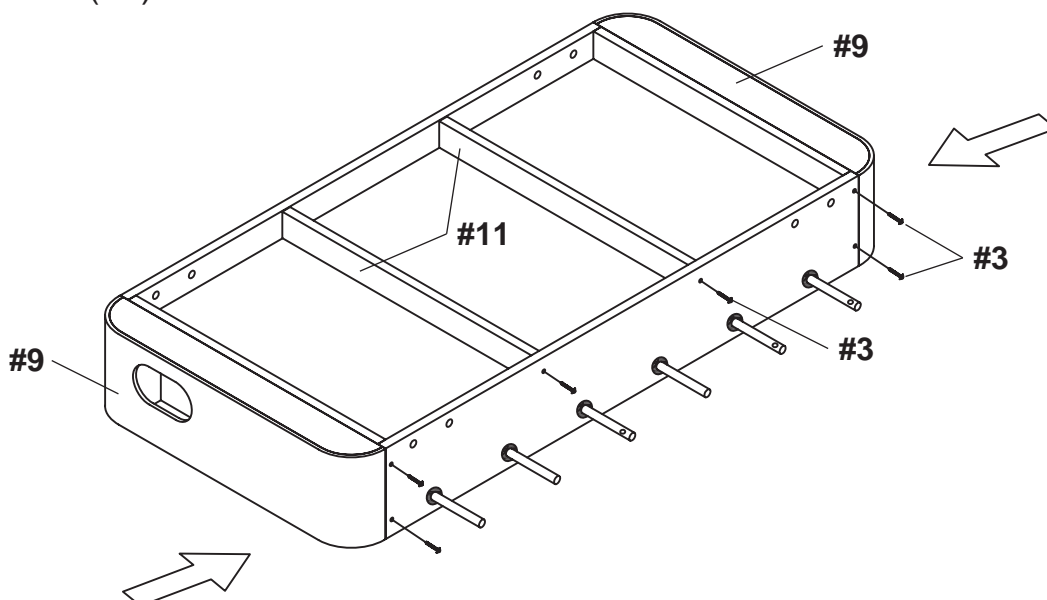

**Step 4-** Attach the Right Leg (#7) and Left Leg (#8) to cabinet using Leg Bolts (#1) and Washer (#2) with Allen Wrench (#5).

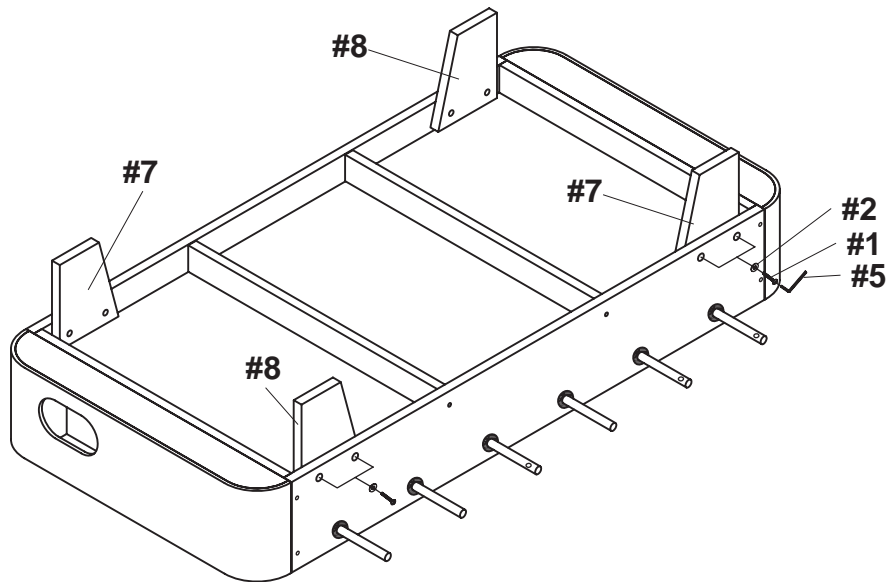

**Step 5-** Carefully flip the table over. Attach the Rod Handle (#13) and the Rod Cap (#14) to the rod. Attach the slide scorer (#12) to the top rails of the End Panels using Screws (#4).

